

FIG. 1

FIG. 2

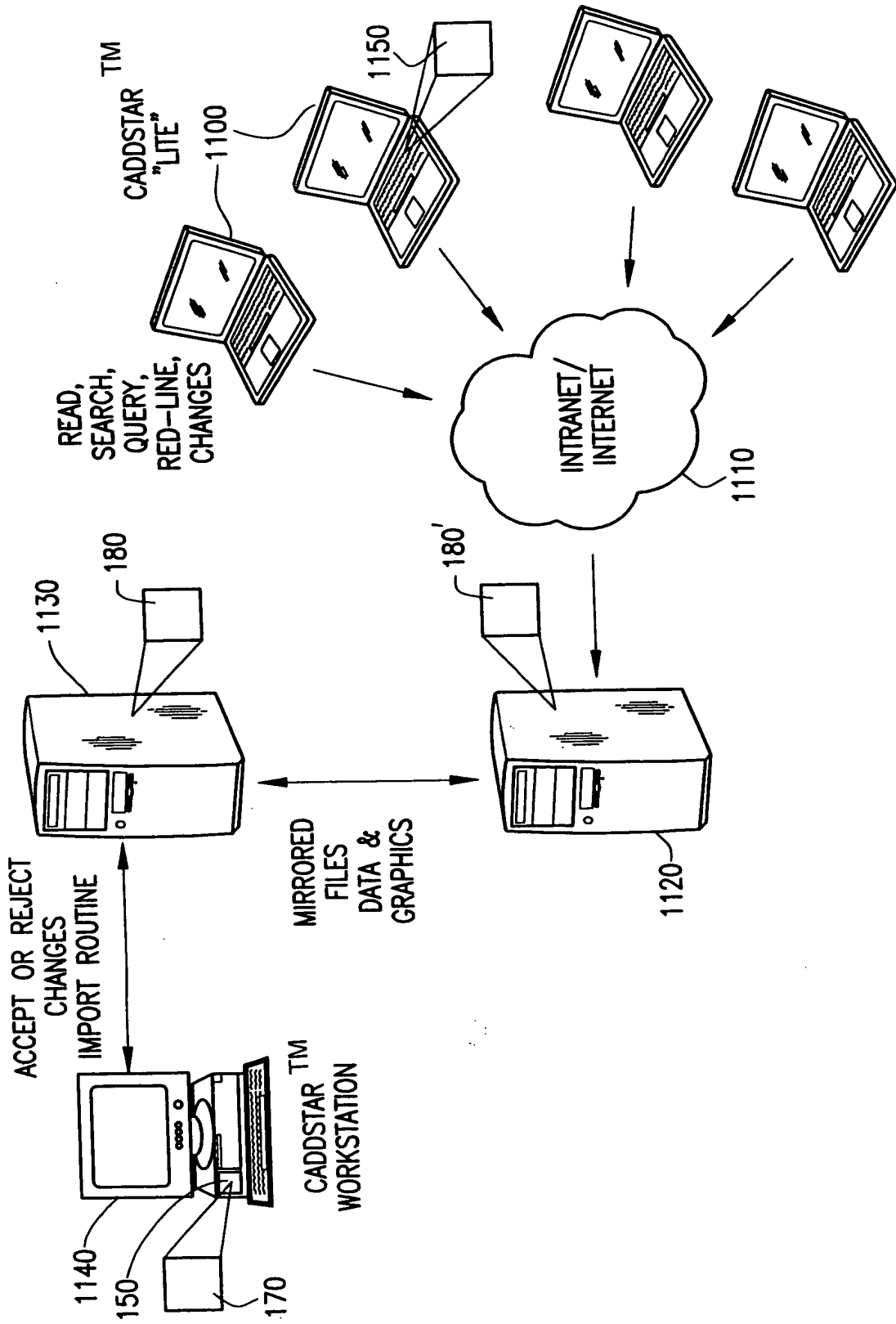

FIG. 3

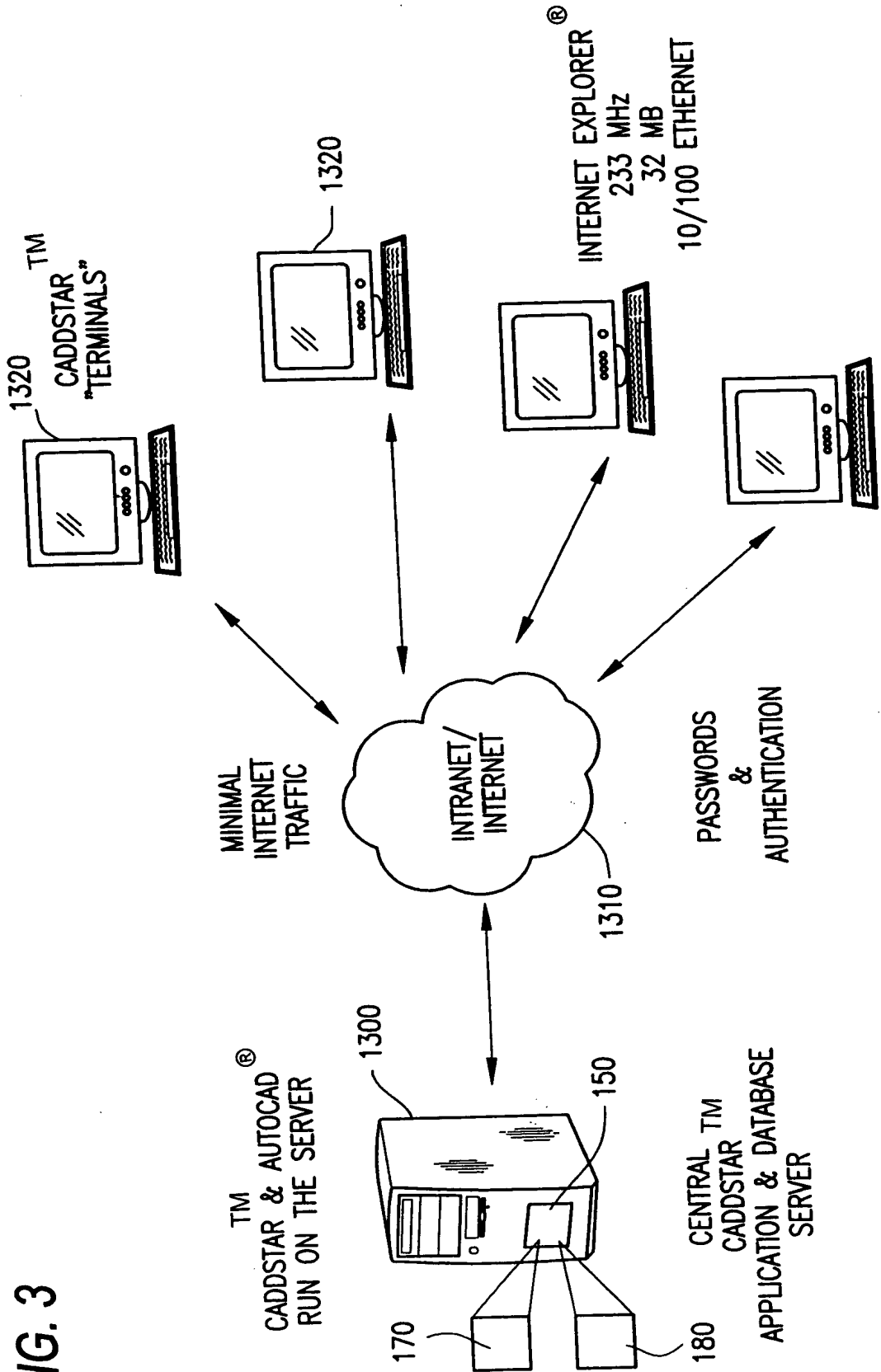
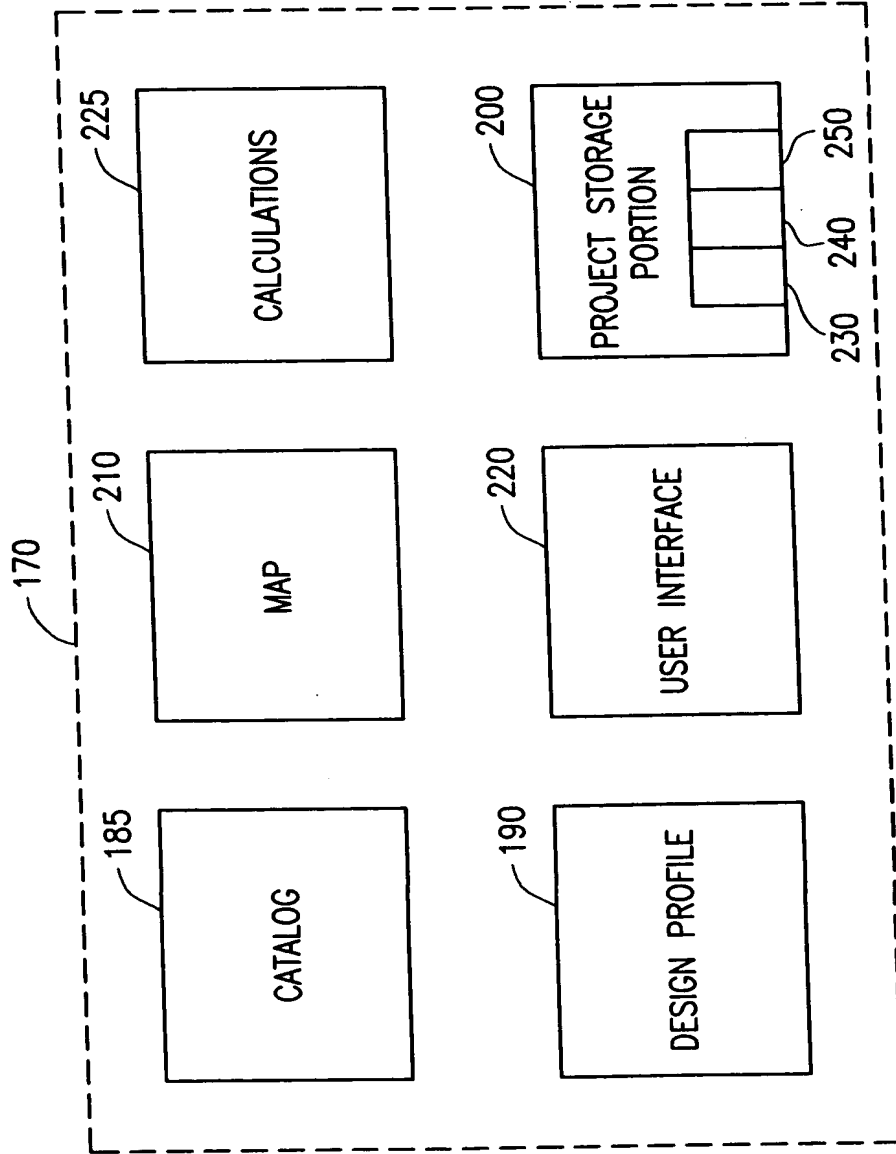
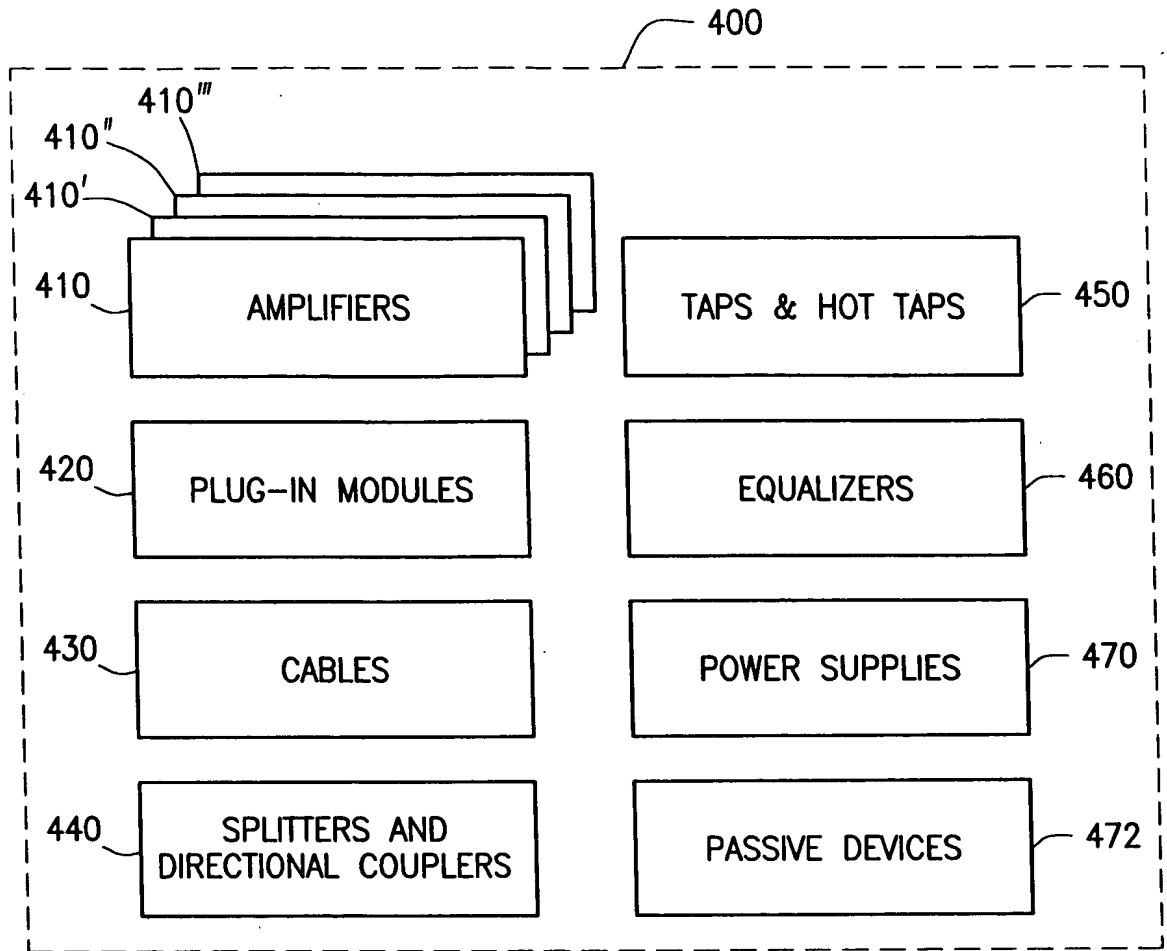

FIG. 4



**FIG. 5 A**



**FIG. 5 B**

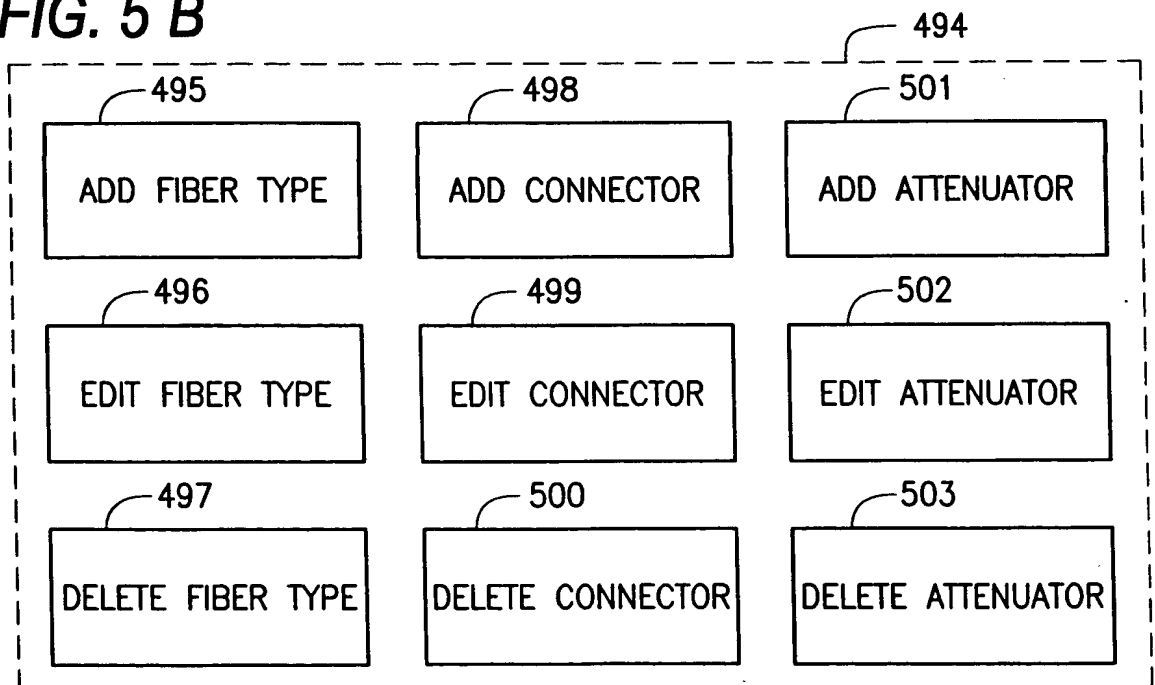

FIG. 6

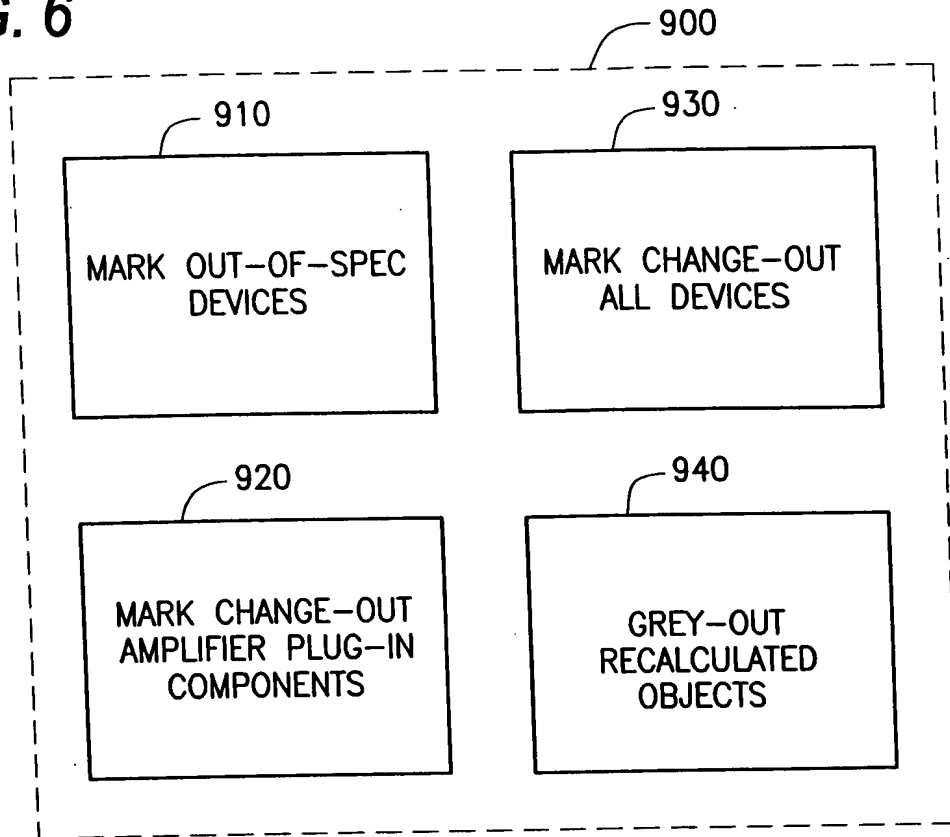
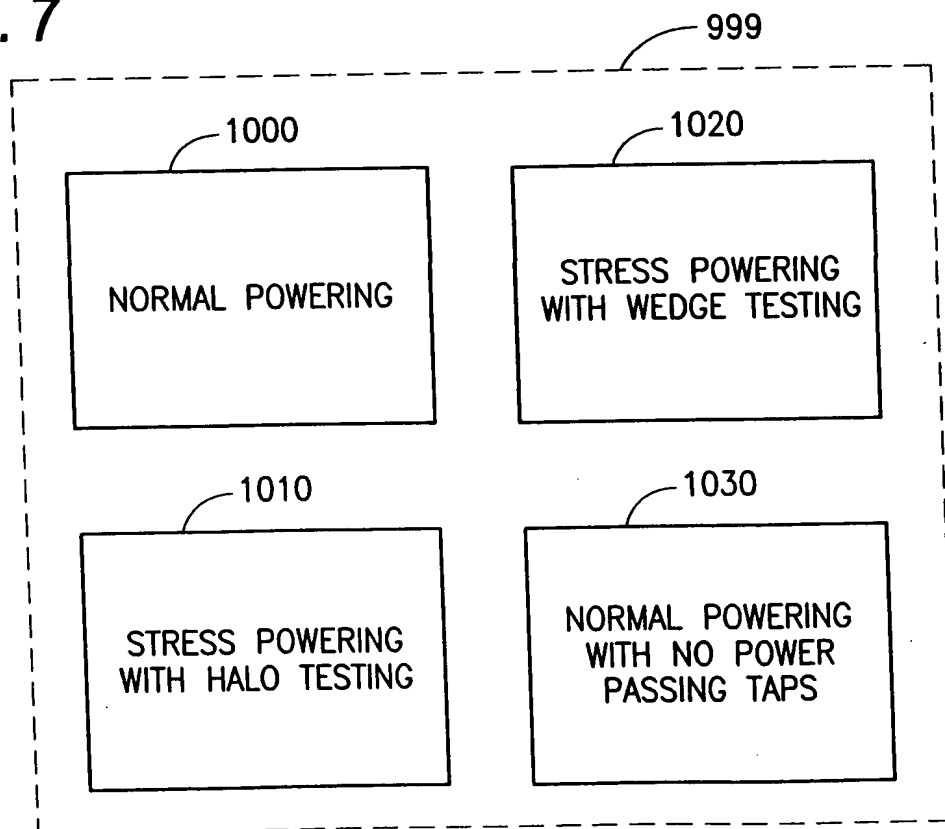

FIG. 7



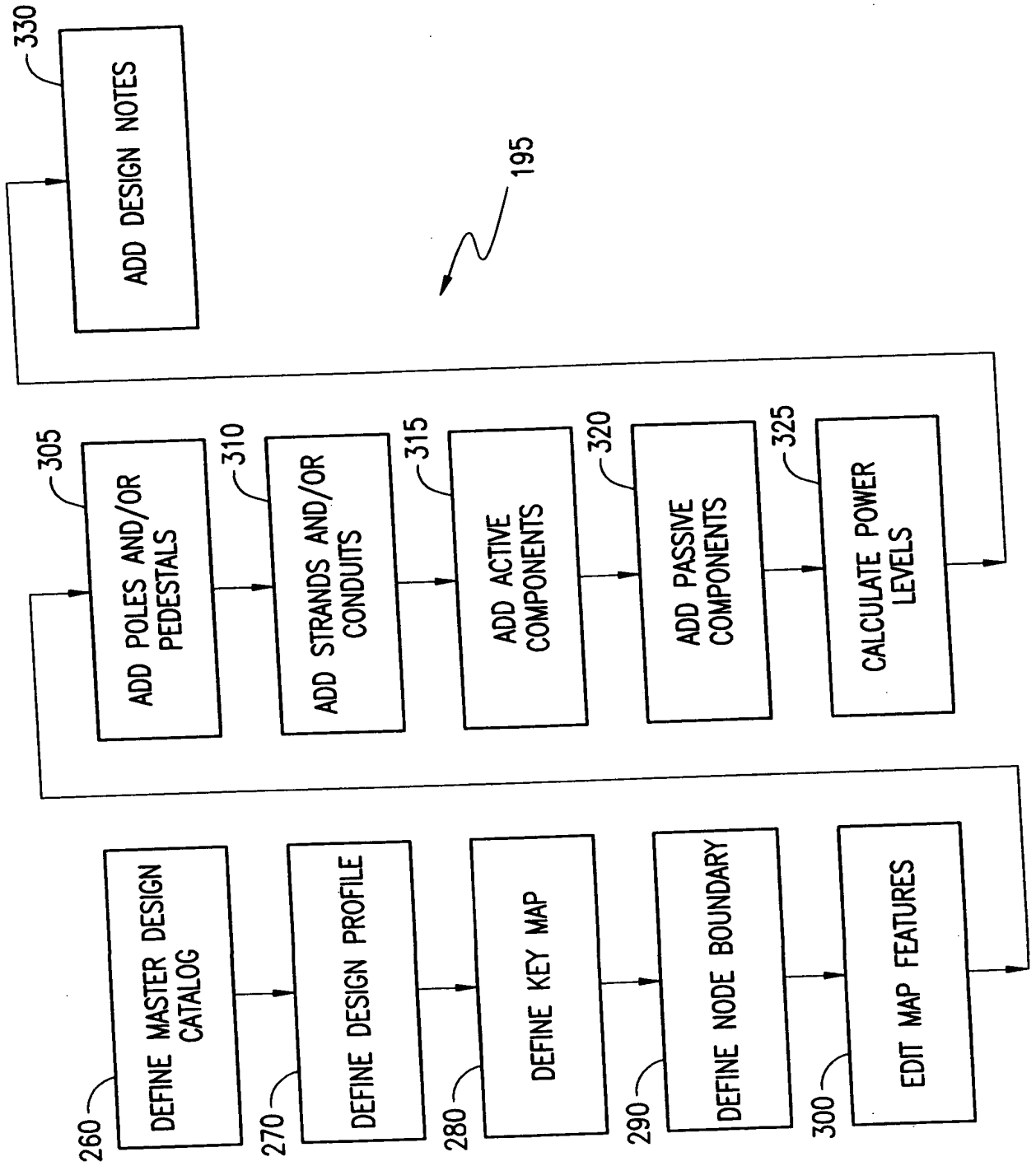
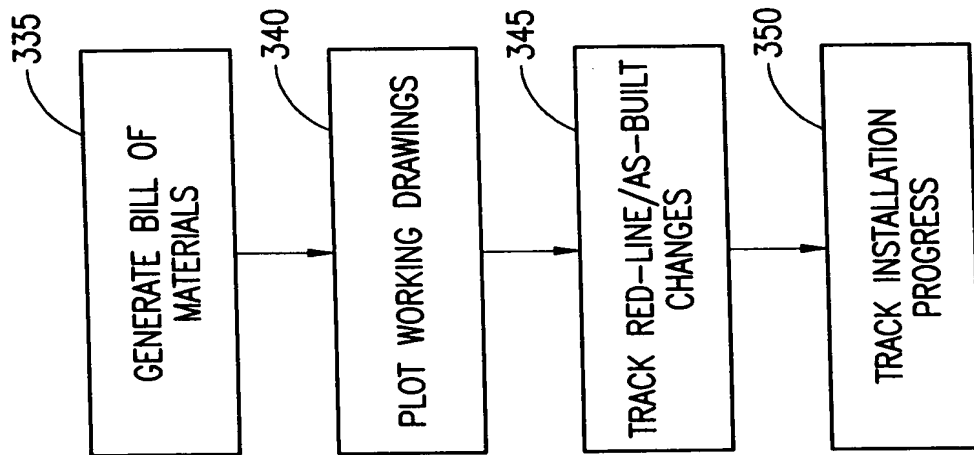

FIG. 8 A

FIG. 8 B





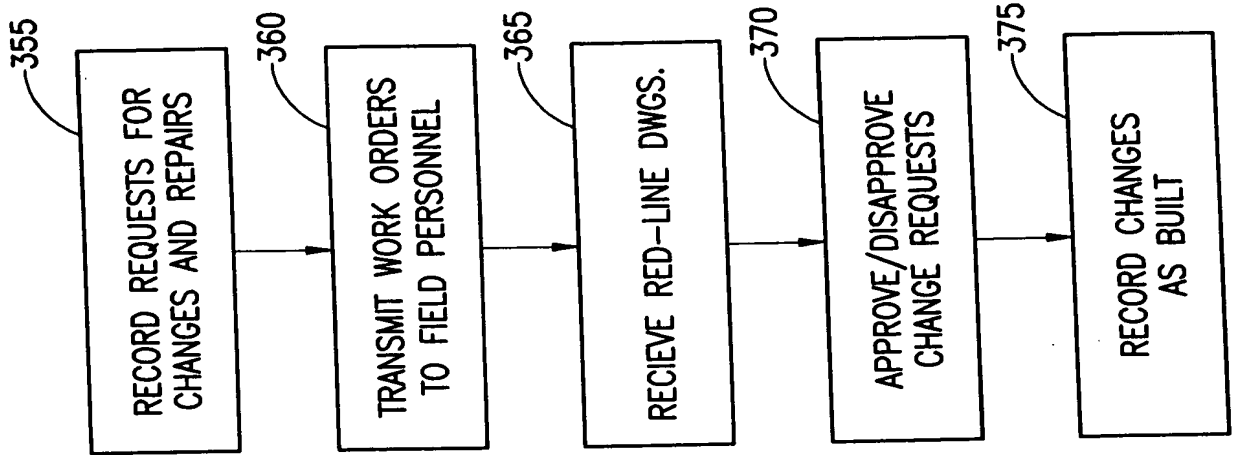

FIG. 8 C

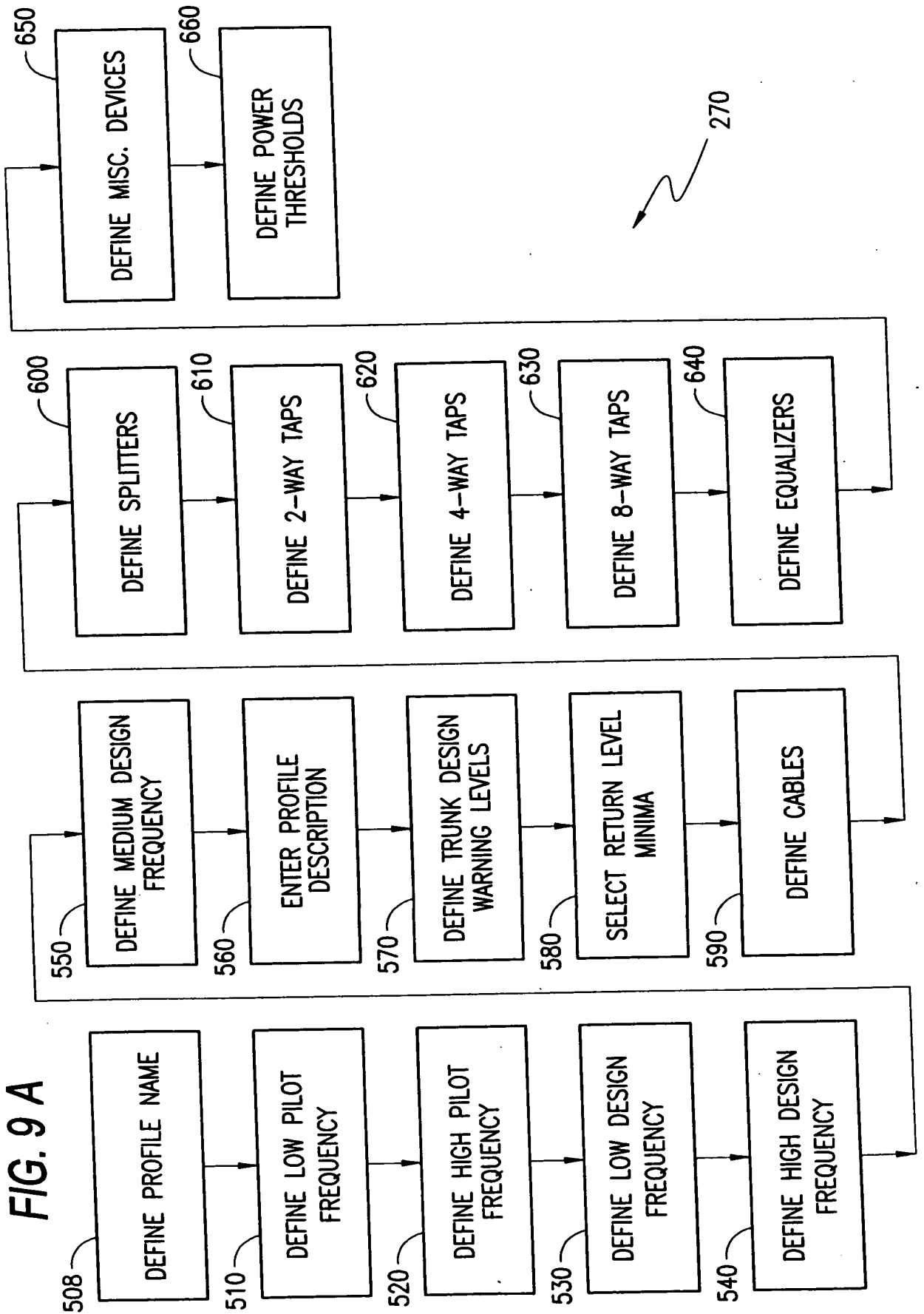

FIG. 9 A

FIG. 9 B

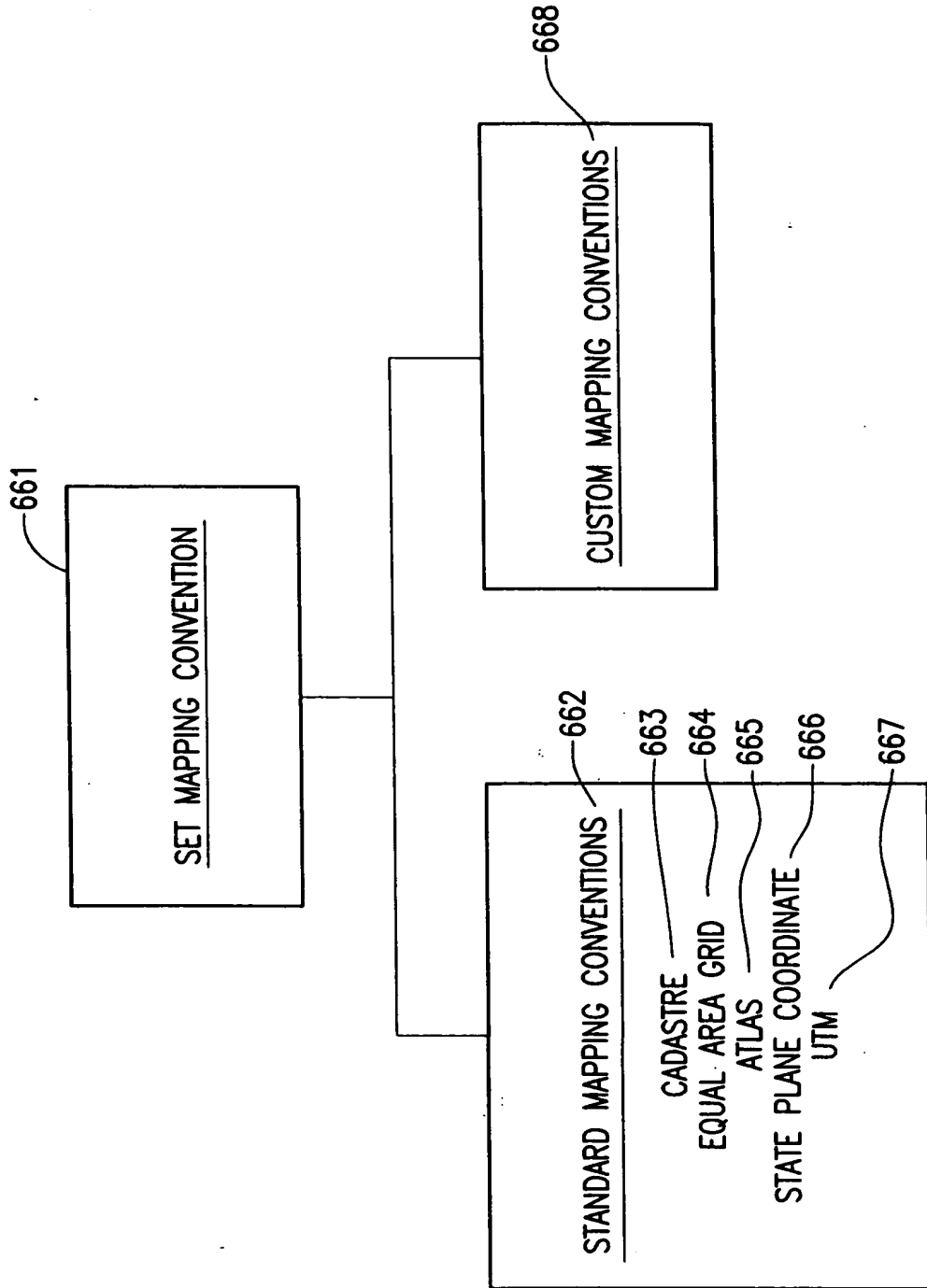
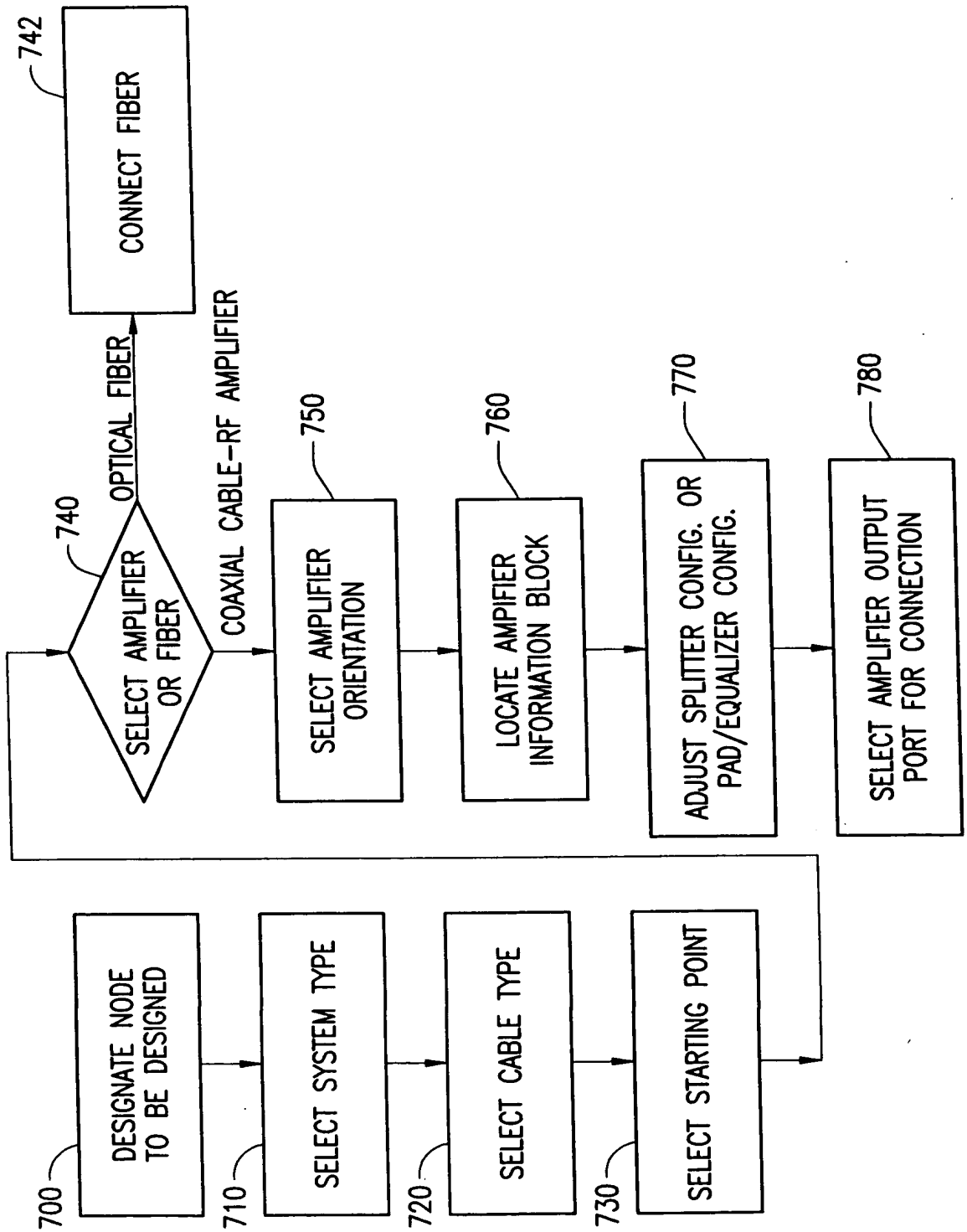

FIG. 10



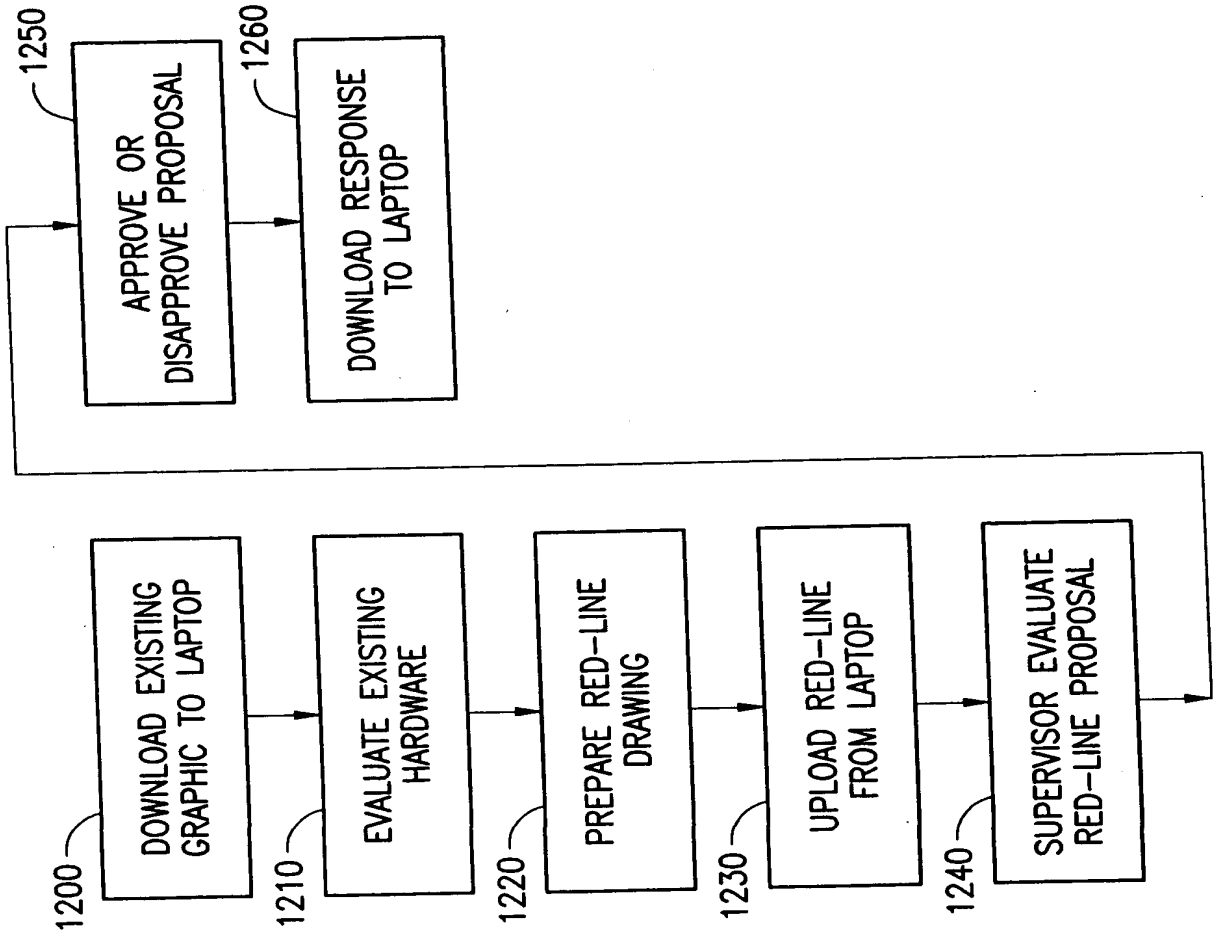

FIG. 11

FIG. 12 A

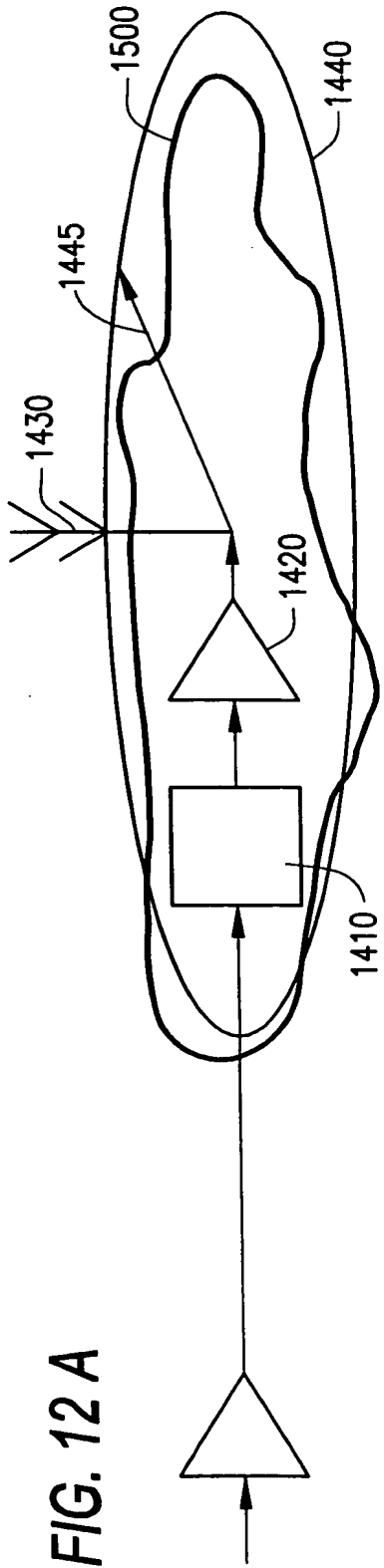

FIG. 12 B

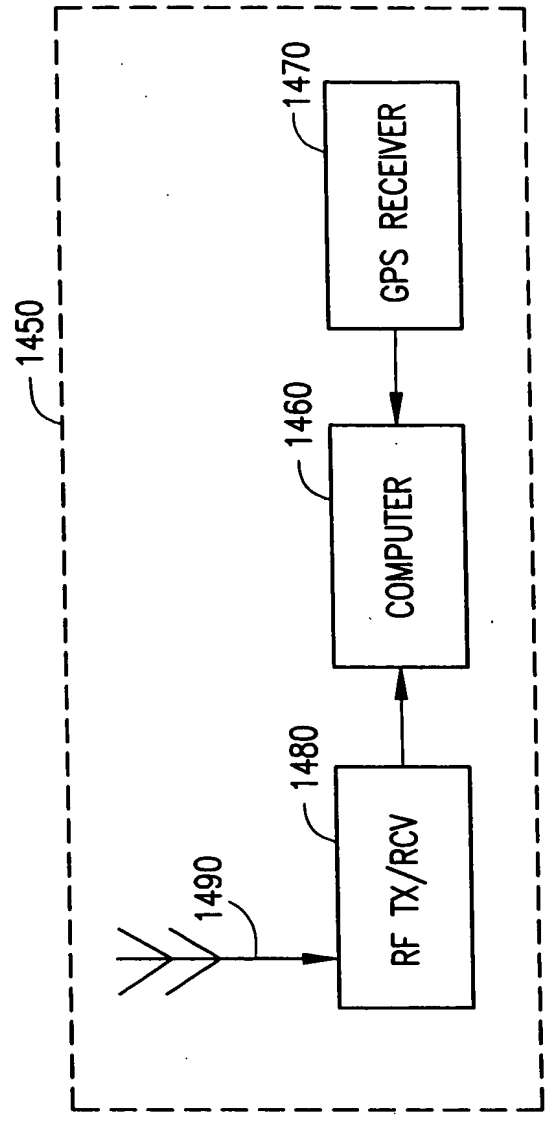

FIG. 13

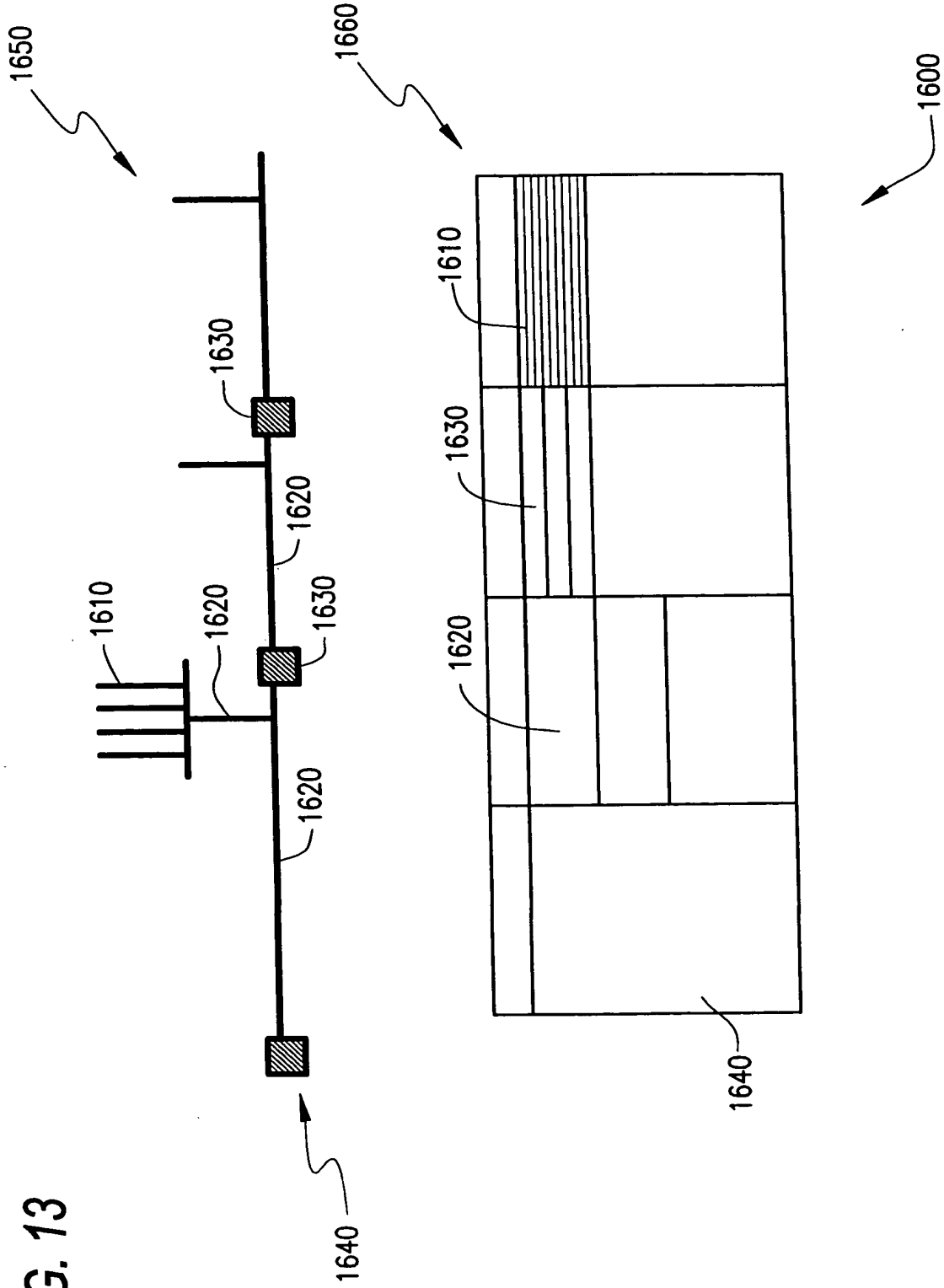
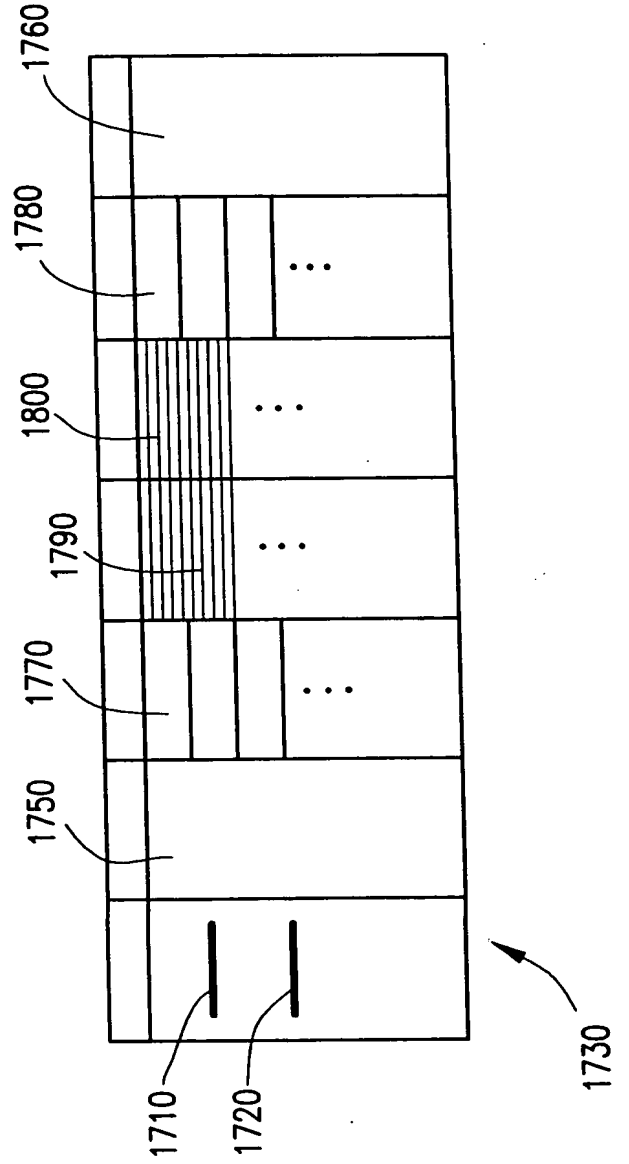
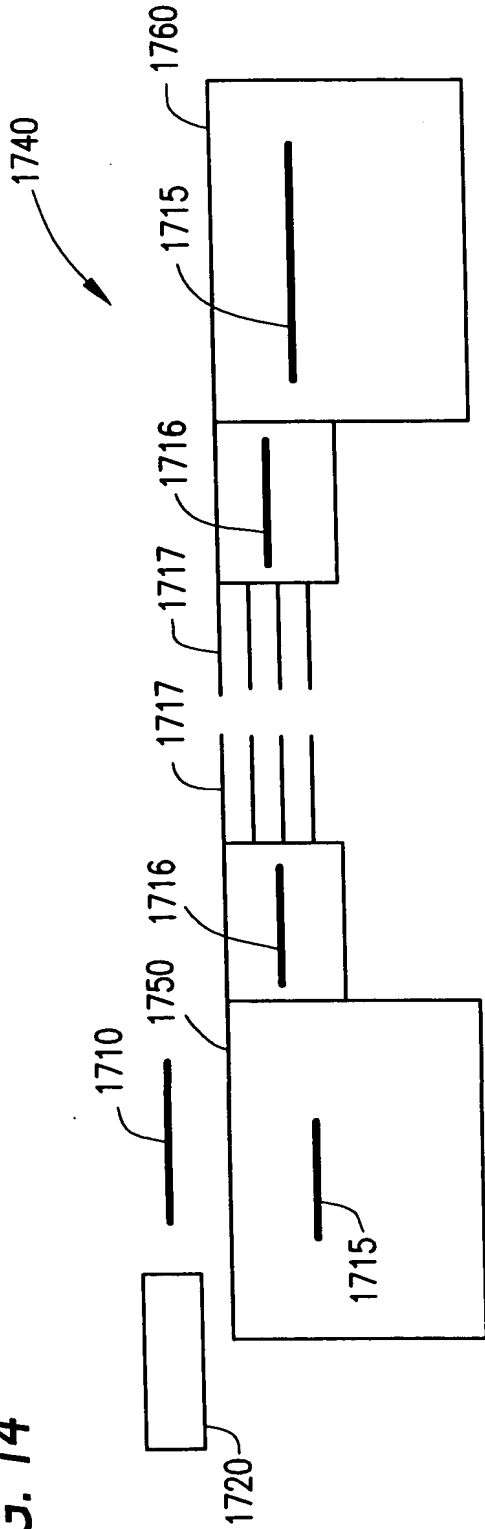

FIG. 14





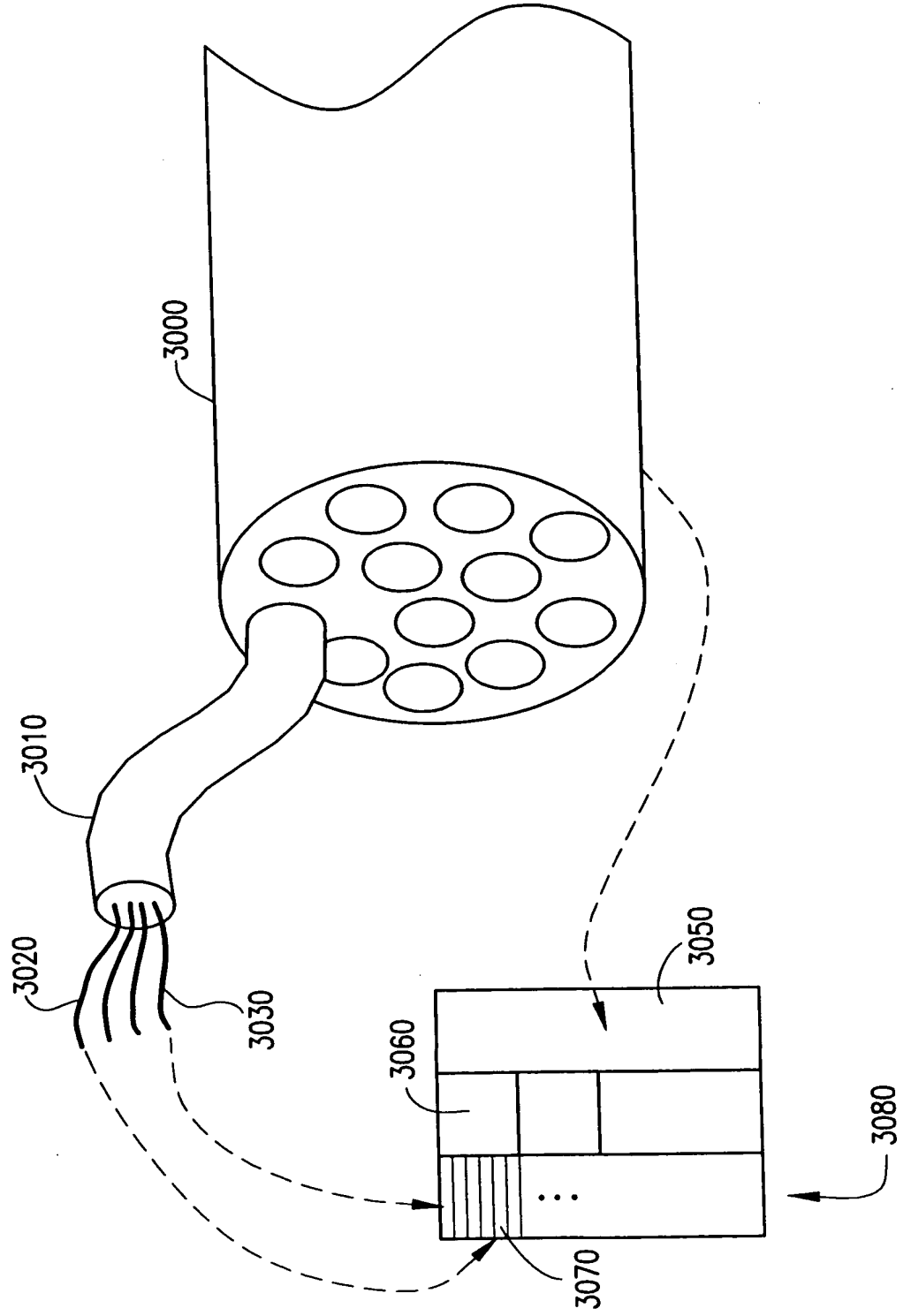

FIG. 15 A

FIG. 15 B

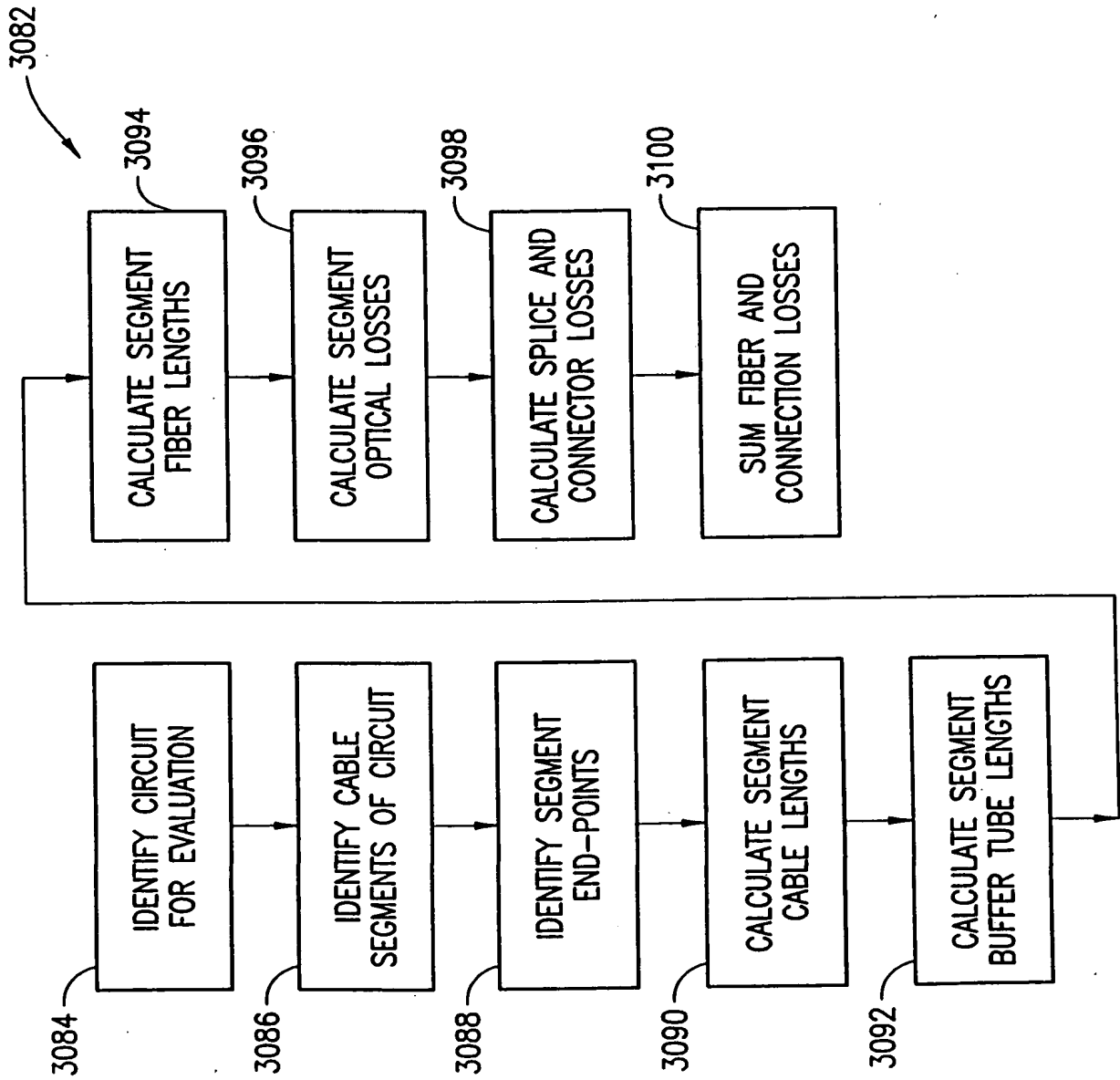

FIG. 16

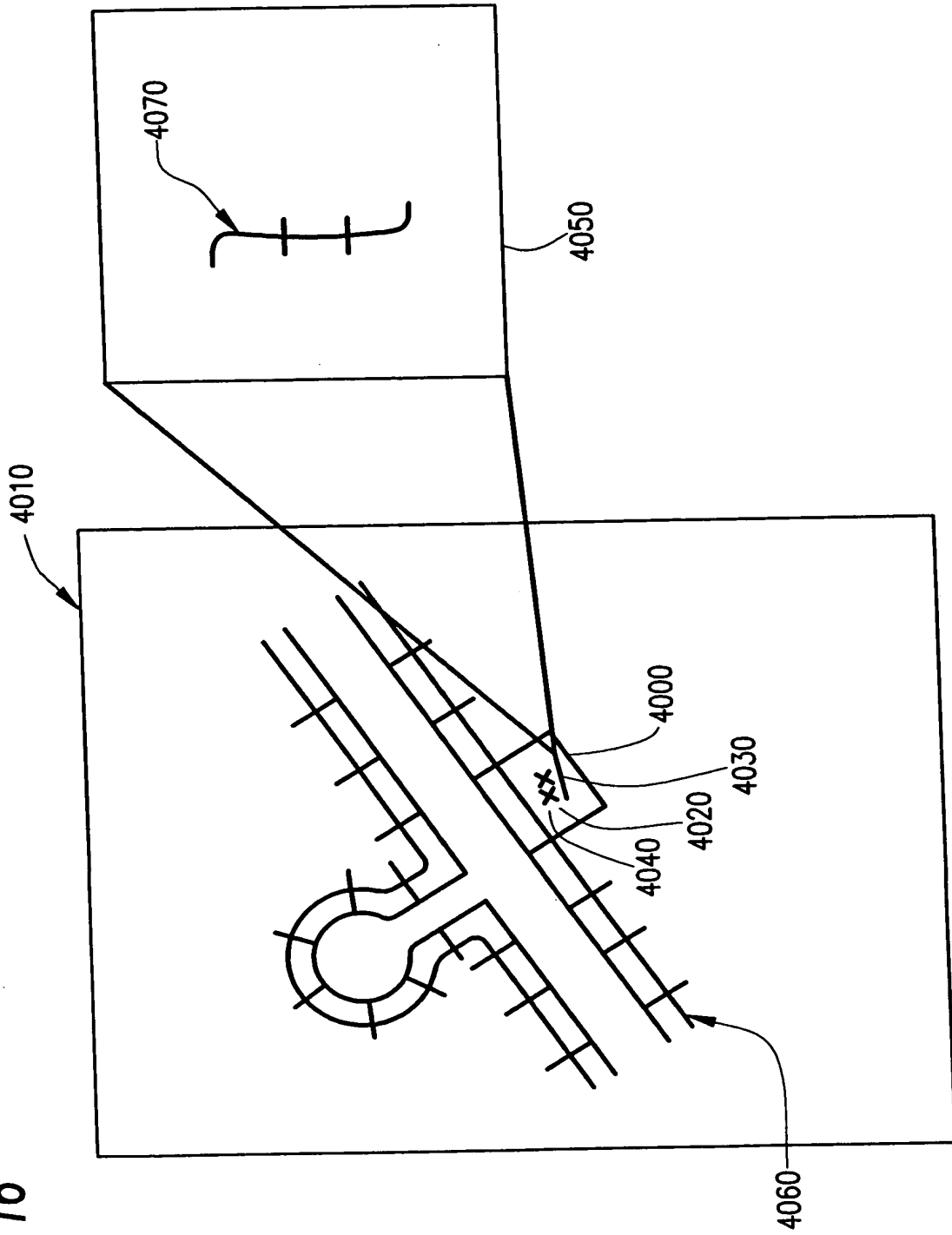

FIG. 17

